



Door Closer

DORMA TS 73 V

New

- ideal dimensions
- optimised features

Easy to fit, economical and with adjustable closing force

Simple, easy installation, and guaranteed quality.

Tested to EN 1154

Specially designed for internal doors, including fire doors, the DORMA TS 73 V is a universal solution for doors of differing designs and styles.

The flat and compact format of the TS 73 V means that there are practically no problems with installation; and tried and trusted quality is your assurance of reliability. Certified to ISO 9001

Why everyone gains – point by point

For the trade

- One model for all applications.
- Really practical solutions for special installation situations, thanks to the wide range of accessories.

For the installer

- Quick and simple to fit. Closing force, closing speed, and latching action all set with just a few manual adjustments.
- Only one design for DIN-L and DIN-R doors, and for standard and framefixing.

For the designers

- Compact format in time-less design.
- Attractively-priced solution with optimum reliability.
- Wide range of applications.
- Anti-corrosive design for moist and damp areas.

For the user

- Optimum wall and door protection thanks to "thinking" backcheck.
- Constant closing speed virtually unaffected by temperature fluctuations, with adjustable latch action.
- Smooth door action thanks to high mechanical efficiency.



The TS 73 V complies with the requirements and/or recommendations of the following: CERTIFIRE approved for fire doors

ITT 120; Ref. CF 117

Data and features TS 73 V

Closing force adjustable	Size	EN 2-4
Standard doors ¹⁾	≤ 1100 mm	●
External doors, opening outwards ¹⁾		–
Fire and smoke check doors ¹⁾	≤ 1100 mm	●
Non-handed		●
Arm	Standard	●
	Flat form	●
	Slide channel	–
Closing force adjustable by means of setting screw		●
Closing speed adjustable at 2 separate valves	180° - 15°	●
	15° - 0°	●
Backcheck	self-regulating	●
	adjustable at valve	●
Adjustable latching action	by arm	●
Delayed action		–
Hold-open		○
Weight in kg		1.8
Dimensions in mm	Length	225
	Depth	40
	Height	60
Door closer tested to EN 1154		●
CE mark for construction products		●

● Yes – No ○ Option

¹⁾ For high and heavy doors, external doors, and for doors required to close against high wind pressure, we recommend DORMA TS 83.

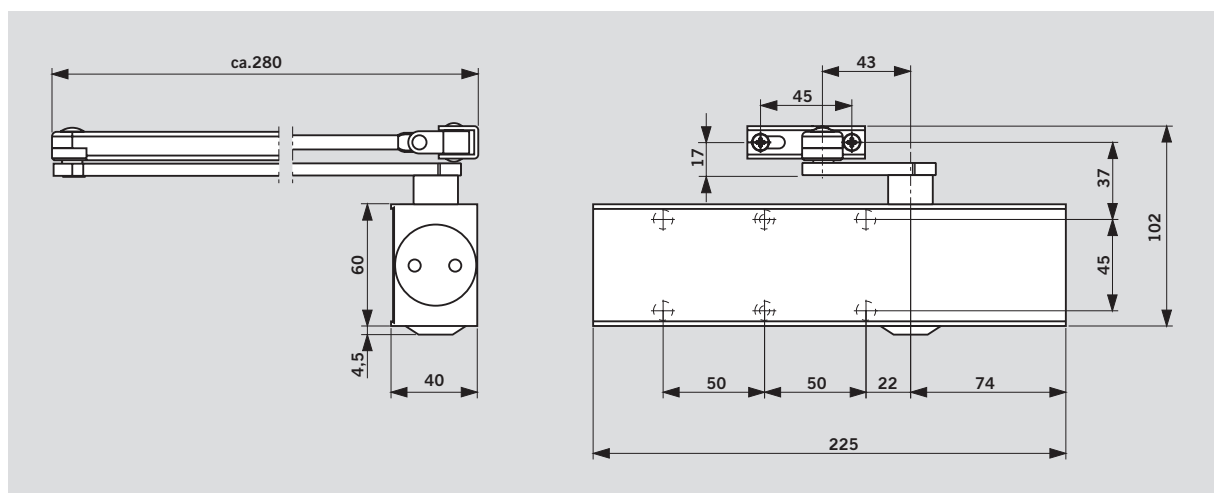

Features and optional functions

With “thinking” backcheck (BC/ÖD)

Thanks to an innovative design concept, the resistance developed by this backcheck system as the door is opened beyond approx. 70° is directly proportional to door acceleration.

It is almost imperceptible when the door is opened slowly. However, if the door is opened hastily, the backcheck responds in equal measure.

And if the door should be flung open at speed – whether deliberately, thoughtlessly, accidentally or as a result of a gust of wind – the backcheck reacts at full strength, protecting the wall and door from damage.

If no backcheck function is required, the system can simply be switched off.

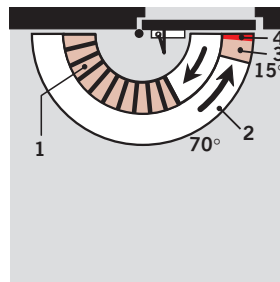

- 1 Self-regulating backcheck
- 2 Infinitely variable closing speed in the range 180° – 15°
- 3 Infinitely variable closing speed in the range 15° – 0°
- 4 Adjustable latch range (by arm)

With hold-open arm

Combining the TS 73 V with a hold-open arm enables the door to be held open at an appropriate angle (up to approx. 150°).

Hold-open arm with switch: The hold-open function can be switched on and off by the user by simply pressing a switch.

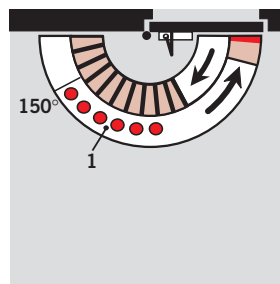

- 1 Hold-open range

Hold-open arms are not permitted on fire doors

Door leaf fixing, pull side (example shows LH (ISO 6) door; RH (ISO 5) doors mirrored arrangement)

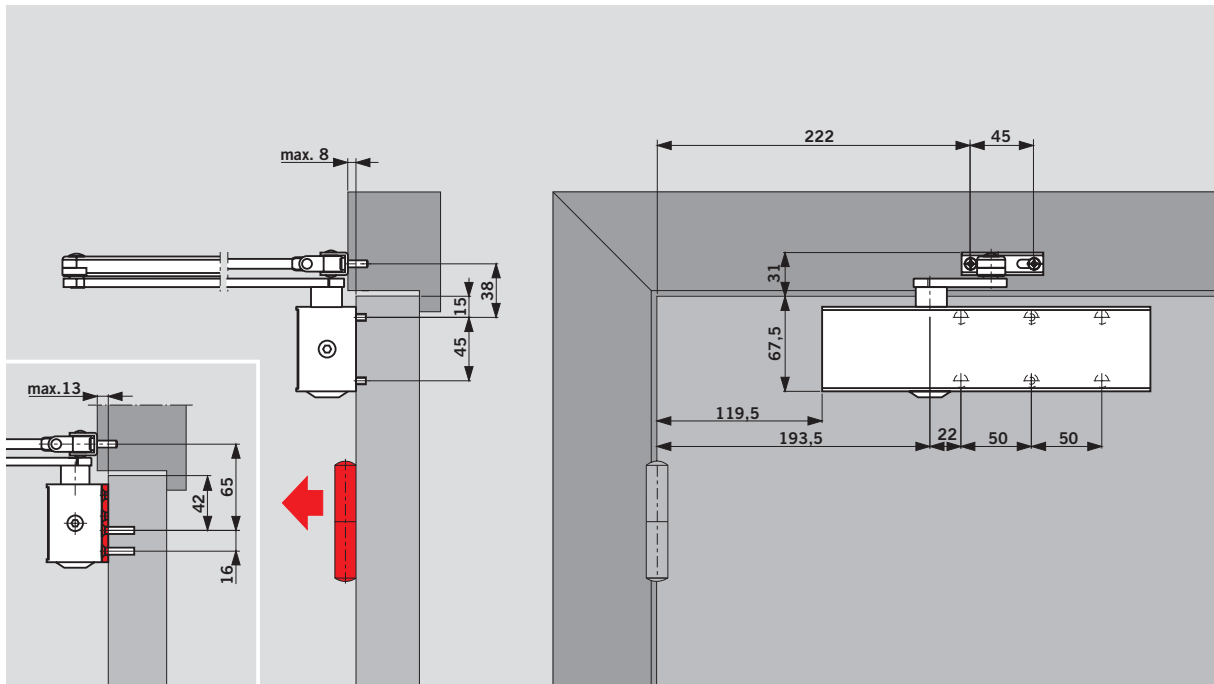

Door leaf fixing with hold-open arm (example shows LH (ISO 6) door; RH (ISO 5) doors mirrored arrangement)

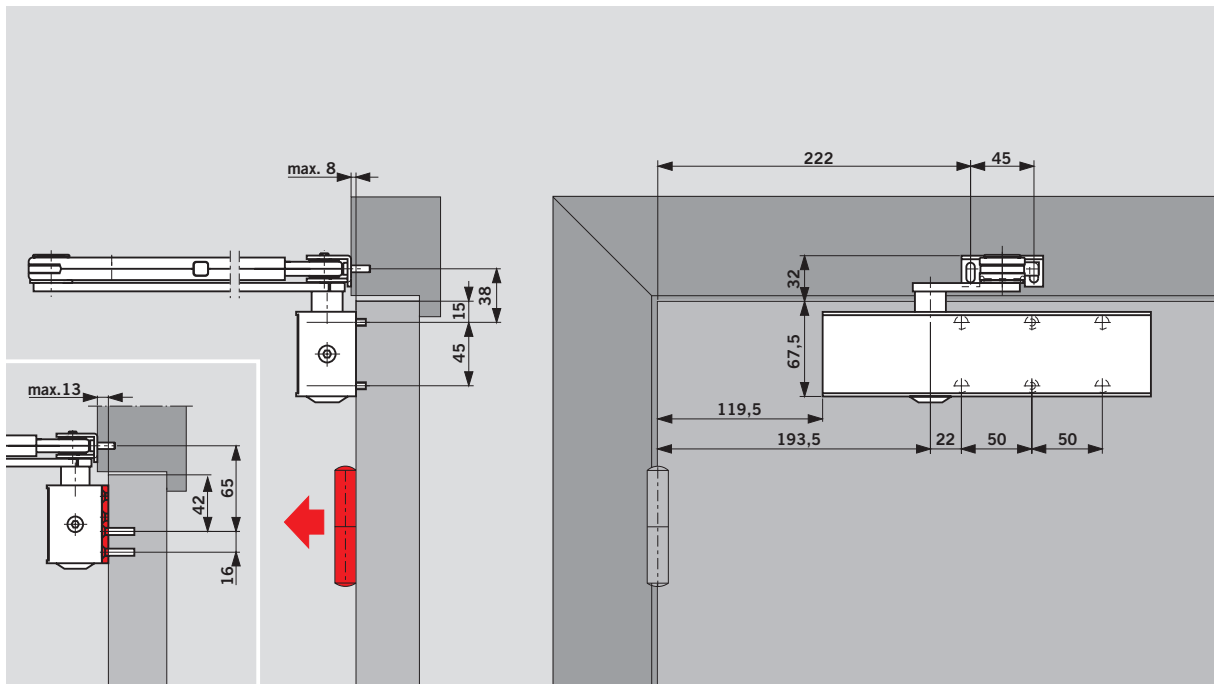

Transom fixing, push side (example shows LH (ISO 6) door; RH (ISO 5) doors mirrored arrangement)

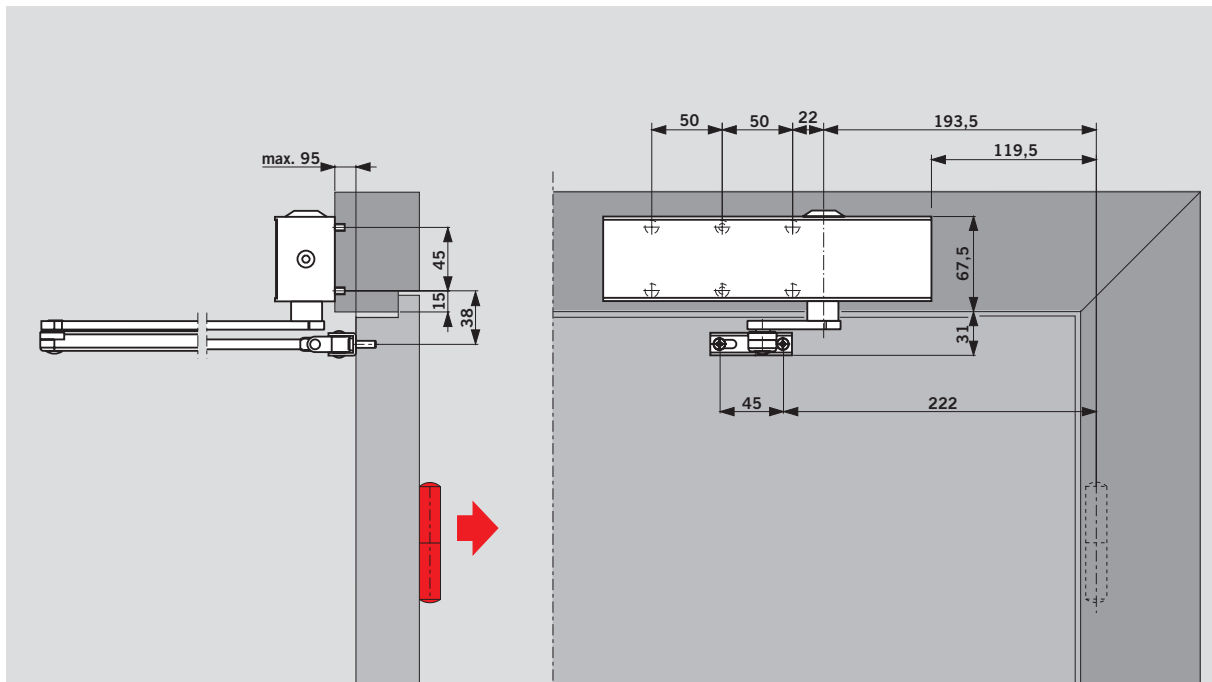

Door closers may only be fitted on the frame of fire doors if proved suitable for the individual door by the issue of an approval certificate from a recognised testing institution.

Mounting plate

For fitting the door closer to fire doors and to doors where direct fitting is not possible. Hole group according to EN 1154, supplement 1.

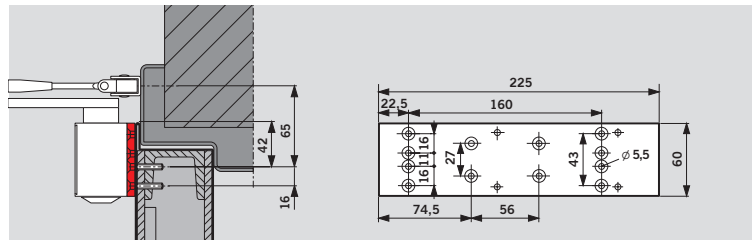

Hinge plate

For securing the arm to particularly narrow door frames.

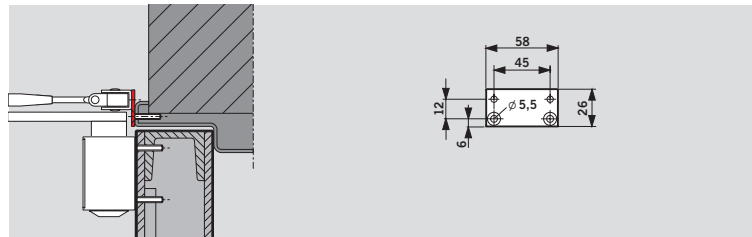

Glass door saddle plate

For securing the door closer to all-glass doors; no need for any glass preparation (to suit 8 – 10 mm door thickness).

Not approved for fire doors.

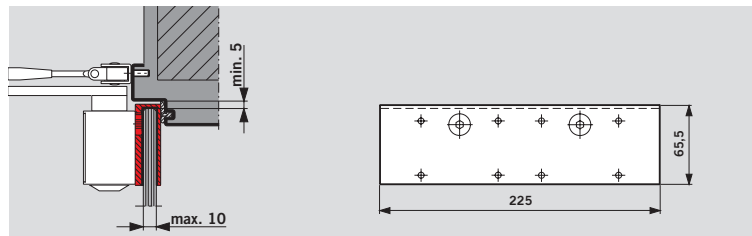

Angle bracket

For overhead fitting on the push side, for deep-set door lintels.

On fire doors, proof of suitability required in relation to the individual door concerned.

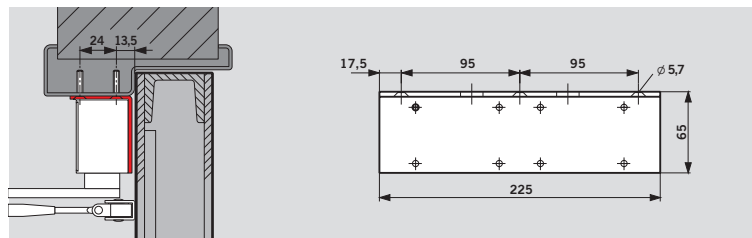

Drop plate

For use where the closer cannot be fitted directly to the door.

On fire doors, proof of suitability required in relation to the individual door concerned.

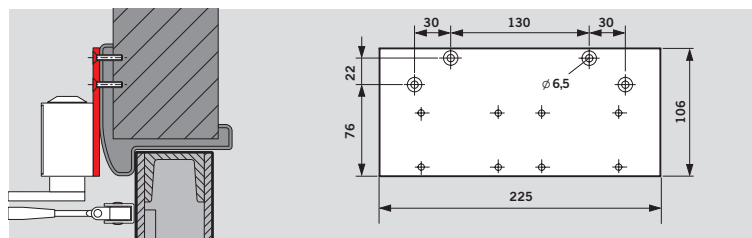

Parallel arm bracket

For parallel arm installation (see installation instructions for fitting dimensions).



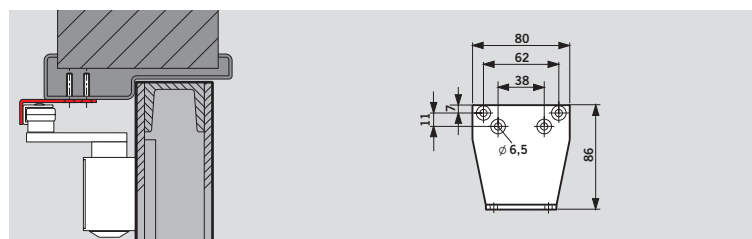





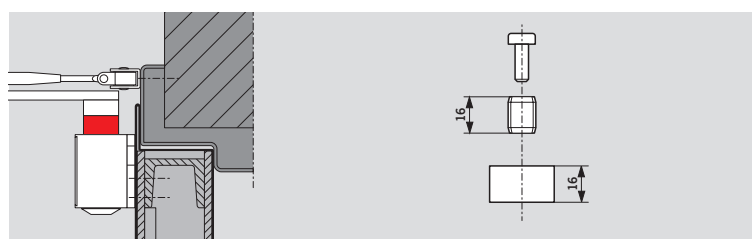



On fire doors, proof of suitability required in relation to the individual door concerned.

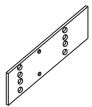

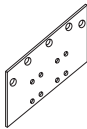
Spindle extension

For increasing the distance between the closer and the arm assembly in the case of doors with a high overlap; 16 mm high.

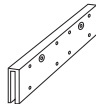

Range of equipment				Accessories			
<p>Closer body TS 73 V</p>  <p>Size EN 2-4</p> <p>370101xx</p>	<p>Standard arm</p>  <p>□ 220023xx</p>	<p>Platform arm</p>  <p>□ 830001xx</p>	<p>Hold-open arm with on/off switch</p>  <p>□ 220030xx</p>	<p>Mounting plate</p>  <p>370001xx</p>	<p>Hinge plate</p>  <p>830014xx</p>	<p>Angle bracket</p>  <p>370003xx</p>	<p>Drop plate</p>  <p>370002xx</p>
				<p>Parallel arm bracket</p>  <p>280066xx</p>	<p>Glass door saddle plate</p>  <p>370004xx</p>	<p>Spindle extension 16 mm</p>  <p>83003705</p>	

Order number: = Body only = Arm only

Colour xx
 silver 01
 white (RAL 9016) 11
 special 09

Specification text

DORMA TS 73 V rack and pinion door closer; with adjustable power size EN 2 – 4, according to EN 1154, carries the CE mark, integral self-regulating backcheck; closing speed adjustable in two independent ranges and adjustable latch action. Non-handed.

- Model**
- with standard arm
 - with platform arm
 - with hold-open arm with on/off switch

Accessories _____

- Colour**
- Silver
 - White (sim. RAL 9016)
 - Special _____ (sim. RAL _____)

Make: DORMA TS 73 V
 TS73V

Частное торгово–производственное унитарное предприятие
«Новые электросистемы»

220024 г. Минск, пер. Корженевского, д. 2а, офис 14

(017) 228–00–00

(017) 207–54–44

(017) 212–77–19

E-mail: info@electrosystem.by

Сайт: www.electrosystem.by